



*An Online CPD Course  
brought to you by  
CEDengineering.ca*

# **Tunnel Operations, Maintenance, Inspection, and Evaluation Manual: Maintenance**

Course No: C02-074  
Credit: 2 PDH

---

Gilbert Gedeon, P.E.

---



Continuing Education and Development, Inc.

P: (877) 322-5800  
[info@cedengineering.ca](mailto:info@cedengineering.ca)

*This course was adapted from the Federal Highway Administration (FHWA) agency of the Department of Transportation, document “Tunnel Operations, Maintenance, Inspection, and Evaluation (TOMIE) Manual – Chapter 3: Maintenance”, which is in the public domain.*

## **TOMIE MANUAL**



### **CHAPTER 3**

### **MAINTENANCE**

## **Chapter 3 – Maintenance**

### **3 Introduction**

An effective maintenance program helps reduce costs, decrease the number of tunnel closures, increase public safety, and ensure adequate levels of service. To maximize efficient use of resources and minimize costs, maintenance programs should be optimized. When large-scale repairs and upgrades are implemented, these projects are typically referred to as tunnel rehabilitation. Maintenance activities range from simple tasks to complex endeavors as indicated in the hierarchy below:

- Removing debris, snow, and ice
- Washing tunnel structures, flushing drains, tightening bolts, and changing light bulbs
- Servicing equipment, painting fixtures, and restoring pavement.
- Tests, verifications, measurements, and calibrations
- Planned interventions
- Unplanned interventions
- Rehabilitation

#### **3.1 Scope of Chapter 3**

The fundamental causes of deterioration and corrosion in tunnels are reviewed in this chapter, and various preventative and on-demand maintenance strategies are presented. This chapter also introduces methods aimed at controlling groundwater seepage. Various repair techniques and rehabilitation schemes are presented with links provided to suggested maintenance tables.

#### **3.2 Deterioration and Corrosion**

Groundwater induces moisture into the tunnel which can accelerate the rate of deterioration and corrosion (See Figures 3.1 and 3.2) especially if road salts, dissimilar metals, and stray currents are involved. Some of the common degradation processes associated with groundwater include:

- Corrosion, section loss, and reduced element strength.
- Removal of material particles and cements, especially when the groundwater is acidic.
- Concrete spalling due to corrosion of reinforcing steel.
- Failure of electrical and electronic components due to corrosion and short circuiting.
- Freeze thaw damage in colder climate.
- Deterioration of the protective finishes and coatings.
- Removal of soil particles with voids created around the tunnel liner.
- Redeposit and clogging of drainage systems.



**Figure 3.1** – Groundwater induced corrosion and deterioration.



**Figure 3.2** – Leakage through shotcrete liner (NCHRP, 2010).

### **3.3 Developing an Effective Tunnel Maintenance Program**

Ideally, the maintenance strategies of a tunnel facility should strike a balance between preventative maintenance and on-demand maintenance. Safety, service requirements, and costs must be considered. When approximately 70% to 80% of all maintenance activities are performed under a preventative maintenance approach, it is considered to be good practice.

The maintenance program should be developed from the existing records of a tunnel facility. Written procedures should be followed to ensure that the tunnel facility receives sufficient maintenance. *If safety or structural concerns are identified in the process of carrying out maintenance tasks, then the defects should be addressed.*

#### **3.3.1 Preventive Maintenance**

Preventive maintenance is conducted to reduce likelihood of failure and to extend the service life of components. An optimized maintenance approach focuses on various preventative maintenance schemes such as cyclical, conditional, and predictive-based methods. With cyclical methods, the maintenance is performed at pre-determined intervals. This approach is common when there is an established service-life. Conditional maintenance draws upon observations and measurements to gauge the onset of failure. An example of this scheme is the use of wear indicators on fan belts, drive chains, and sprockets. Predictive maintenance is based on mathematical forecasting models and statistical analysis. These methods use data-driven, risk-based strategies as discussed in Chapter 5 of this manual.

#### **3.3.2 Corrective or On-Demand Maintenance**

On-demand maintenance is sometimes referred to as corrective maintenance. This type of maintenance is the most effective strategy against difficult-to-predict occurrences such as damage from vehicle impacts, sudden equipment malfunctions, or unanticipated tunnel system failure. Contingency plans should be developed in advance to facilitate the repair process and return the tunnel to service.

#### **3.3.3 Tunnel System Rehabilitation**

Individual tunnel systems are often rehabilitated when they are near the end of their useful life. Rehabilitation, also called refurbishment, implies that a large-scale repair program is being developed with extended durations, substantial engineering input, and substantial costs. Tunnel rehabilitation includes projects such as overhauling the ventilation systems, upgrading the fire suppression equipment, replacing the lighting system, or making extensive structural repairs.

### **3.4 Types of Maintenance Activities**

Maintenance activities include removing debris, snow, and ice; washing tunnel structures, flushing drains, tightening bolts, and changing light bulbs; and servicing equipment, painting fixtures, and restoring pavement. Maintenance also involves conducting tests, verifications, measurements, and calibrations on equipment, machines, and systems.

#### **3.4.1 Removing Debris, Snow and Ice**

Debris, snow, and ice present a number of safety concerns. Debris should be removed from the tunnel on a regular basis since it could obstruct vision, damage vehicles, foul equipment, or present a fire or safety hazard. In cold regions, icicles above the roadway should be removed since they could damage vehicles. Deicing agents should be used to clear ice from sidewalks,

roadways, and approaches. Ice should also be removed from areas that are not designed to carry potentially ice loads (See Figure 3.3).



**Figure 3.3** – Ice formation in plenum area above ceiling slab.

### **3.4.2 Tunnel Washing**

The tunnel should be washed when the interior becomes dull with dirt (See Figure 3.4). Washing is also recommended to make the inspection work easier. The washing process consists of spraying the tunnel with water and detergents, scrubbing the surfaces with rotating brushes, and rinsing off the soap and grime using water jets. The frequency of washing varies from one tunnel facilities to the next because of environmental conditions, traffic levels, and the type of vehicles such as diesel burning trucks. Some tunnels should be washed quarterly, while others might only be cleaned annually. Tunnel washing is sometimes suspended during winter months to prevent the formation of excessive ice buildup.

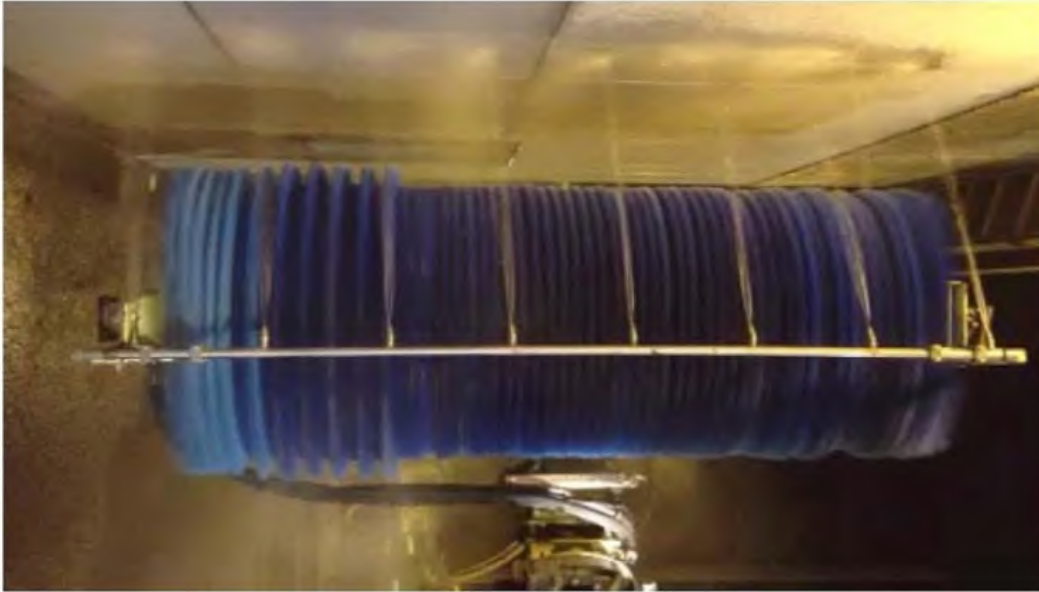

**Figure 3.4** – Washing the tunnel.

### **3.4.3 Servicing Vehicles and Equipment**

Vehicles and equipment should be serviced periodically to ensure readiness and performance. When servicing vehicles, the engines and motors should be checked for things such as appropriate fluid levels, unusual sounds, excessive temperatures, and abnormal vibrations. The gauges and readout units should indicate normal operating levels. Any leaks from oil, grease, fuel or fluid should be noted in the log book and remediated. When checking the electrical components, look for torn, ripped, or frayed insulation and signs of corrosion, arcing, or overheating. Preventative measures include actions such as:

- Routinely monitor equipment, collect data, record findings, and maintain logs.
- Analyze the data to identify if there are any trends (vibration, oil analysis, operating temperatures, bus temperatures, lighting levels, water pressure) that indicate component failure.
- Stock a reasonable supply of spare parts.
- Sometimes equipment can be operated at reduced capacities but only when it is safe to do so.
- Negotiate prices in advance with specialty contactors and equipment vendors.
- Evaluate rental equipment options and negotiate rental agreements in advance of the equipment breakdown.
- Retain manufacturer documentation (e.g., operation manuals, spare parts lists, recommended maintenance practices, schematics).
- Document repair processes and replacement activities. Identify the key issues and develop aids such as checklists and schematics.
- Maintain cost records for parts, equipment, contracts, and labor.
- Provide mentoring and develop a training program for all of the maintenance staff.



#### **3.4.4 Drainage Inlets and Pipes**

Roadway drain inlets should be cleaned of debris and flushed with water to prevent clogging. These activities should be scheduled with tunnel washing activities. Plumbing snakes and down-the-hole video cameras can be inserted into pipes with cleanouts to help identify problem areas within the concealed string. The drainage system should be monitored during periods of cold weather to reduce any occurrence of pipe freezing and possible subsequent bursting.

#### **3.4.5 Luminaire Cleaning and Replacement**

Lighting and visibility play an important role in accident prevention. Lights should be easy to service to limit lane closures and maintenance time. Lights should be sealed from harmful environmental effects and keep out moisture, bugs, and dust. Luminaires that facilitate rapid bulb replacement are ideal.

#### **3.4.6 Pavement Markings and Signs**

Pavement markings and signs should be cleaned when they become dull and repainted, as necessary, for luminosity. When traveling through the tunnel at the allowable speeds, the motorists should be able to clearly identify the pavement markings and signs.

### **3.5 On-Demand Maintenance**

On-demand maintenance activities are used in response to events that are more difficult to predict such as impact damage, concrete spalling, equipment failure, and gaping potholes. This method is also appropriate for the repair or replacement of noncritical items that have minimal impact on tunnel safety and the required service levels. If the impact is potentially significant, appropriate contingency plans should be developed to minimize the adverse effects.

#### **3.5.1 Damage to Tunnel**

Among other things, tunnels can be damaged by vehicle collisions, fires, explosions, floods, earthquakes, rock slides, and landslides. After one of these incidents, a damage inspection should be conducted in accordance with the guidelines provided in Chapter 4 of this manual.

#### **3.5.2 Concrete Detachment**

Concrete can loosen and detach because of faulty placement techniques, corrosion of rebar, damage from excessive heat, impact from vehicles, and deterioration. Some of these processes may occur without warning. When concrete debris is discovered in the roadway portion of the tunnel, it should be cleaned up immediately; and any loose or dangling concrete should be removed using small hand-held hammers, pry bars, jack hammers, or other appropriate tools.

#### **3.5.3 Sudden Equipment Failure**

Equipment failure can be difficult to predict, particularly when electronic components are involved. Appropriate contingency plans should be ready for implementation to restore service as quickly as possible. An effective preventative maintenance program can help reduce the burden placed by on-demand maintenance.

#### **3.5.4 Pavement Repair**

Roadway wearing surfaces are typically comprised of concrete or asphalt materials. Sealing cracks and patching potholes are part of roadway maintenance. Extensive subgrade repairs may be needed due to freezing, insufficient drainage, or loss of fines in the subgrade. Pavement repairs should not be allowed to impact the vertical clearances of the tunnel.

### **3.6 Groundwater Seepage through Liners**

Groundwater seepage can be controlled temporarily by interim solutions using catchment troughs and interior composite liners; however, these temporary solutions do not protect the final liner from long-term corrosion and degradation. Before implementing these methods, an engineer should evaluate the potential for:

- Fine soil particle migration, void creation, and redistribution of the stresses around the tunnel liner.
- Fine soil migration, re-deposition, and drain clogging.
- Protection of structural materials from corrosion and further degradation.
- Settlement of adjacent structures because of soil or rock mass dewatering.
- Vehicle strikes due to insufficient clearance of new installed materials.
- Obscuring important safety defects during future inspections of the final liner.

#### **3.6.1 Catchment Troughs and Pipes**

Troughs may be installed on the inside of the liner to catch leaking water and convey it into the drainage system using interconnected pipes. These systems have made use of neoprene, steel, fiberglass, and flexible or rigid polyvinyl chloride (PVC) pipes in the past; however, some of the plastic type materials are known to release toxic fumes during fires. Simple catchment systems are shown in Figures 3.5 and 3.6. More robust systems are simply sealed better to minimize the chances of water leaks as shown in Figures 3.7 through 3.11. Sometimes radial drainage holes are drilled into the tunnel liner to relieve the water pressure (See Figures 3.12 and 3.13) behind the liner; this water can be collected and conveyed into the drainage system. The buildup of hydrostatic pressures can be relieved somewhat by draining it, which might ultimately reduce the amount of cracking in the tunnel liner.

The size and type of the trough depends on factors such as the severity of the water infiltration problem, the potential for freezing in the winter, the inclination of the cracks, and considerations for fire in the tunnel. The clogging issues can be minimized by cleaning the system and filtering the water. In colder climates, insulation or heating can generally prevent the formation of ice. Small chipping hammers, wire brushes, and high pressure washers are commonly used to remove efflorescence or deleterious materials prior to installation of these systems.

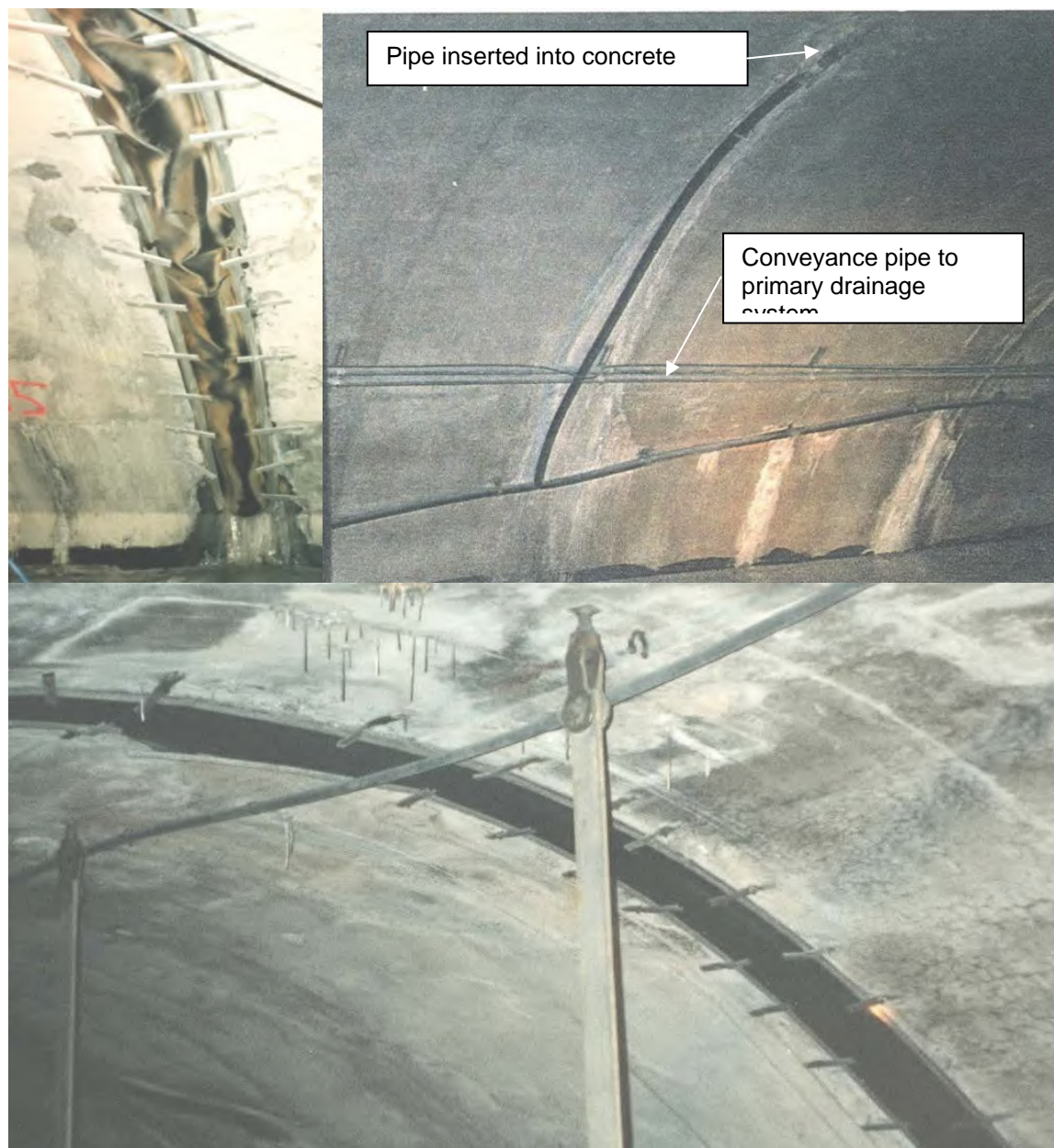

**Figure 3.5** – Temporary drainage systems comprised of neoprene rubber troughs and 25 mm (1”) aluminum channels (FHWA, 2005).

The advantages are:

- Easily constructible
- Fairly inexpensive
- Minimal impact on tunnel operations
- Applicable to common types of cracks.

The disadvantages are:

- Some material are unsuitable for fire
- Heating or insulation is required in colder climates
- Water continues to corrode elements.
- The troughs need to be cleaned to prevent clogging.

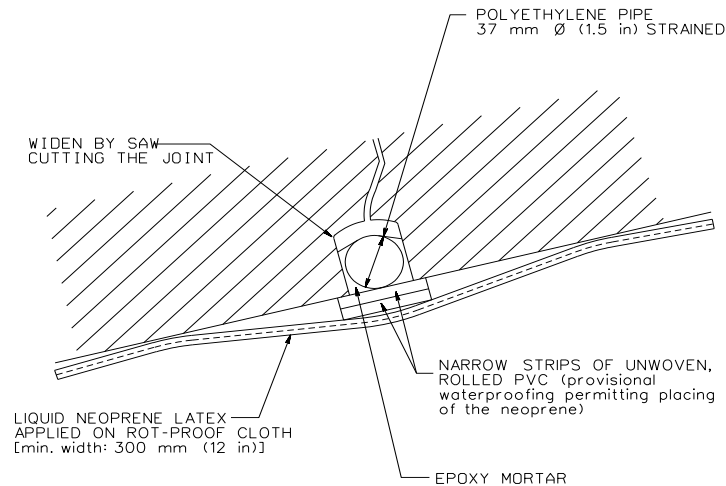

**Figure 3.6** – Treatment using membrane covering and pipes (FHWA, 2005).

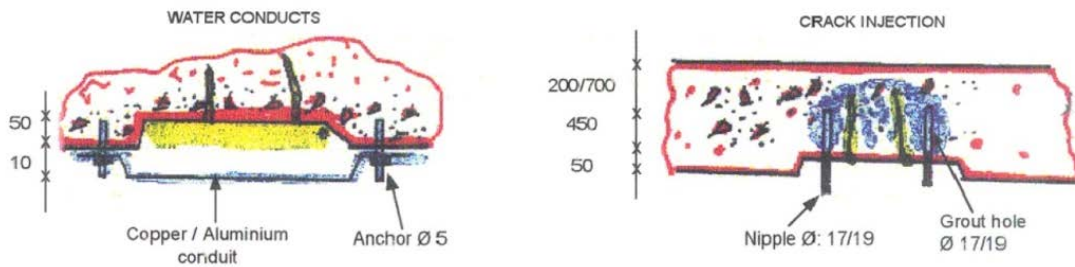

**Figure 3.7** – Copper or aluminum conduit along with crack injection used to convey water penetrating a concrete liner (Russell, 2001)

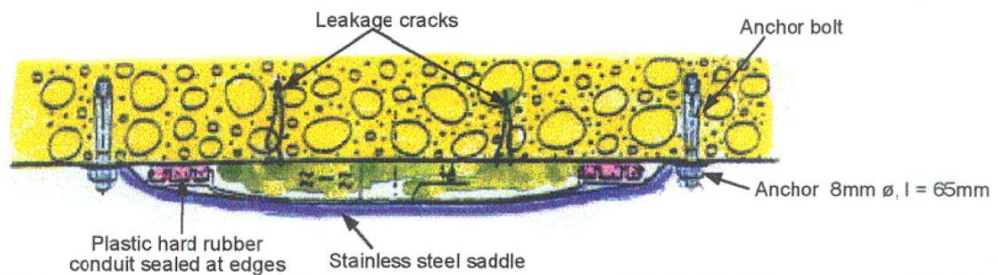

**Figure 3.8** – Stainless steel saddle anchored to concrete for conveying water through leakage cracks (Russell, 2001).

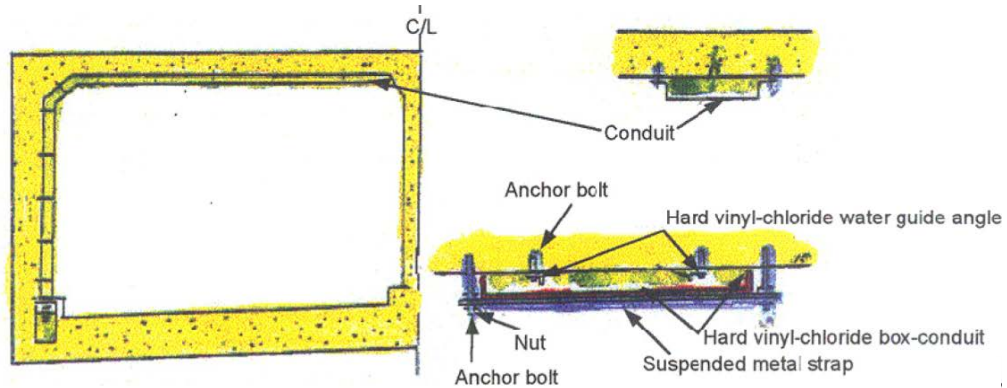

**Figure 3.9** – Hard vinyl-chloride box conduit anchored to underside of cast-in-Place concrete roof to convey water leakage (Russell, 2001).

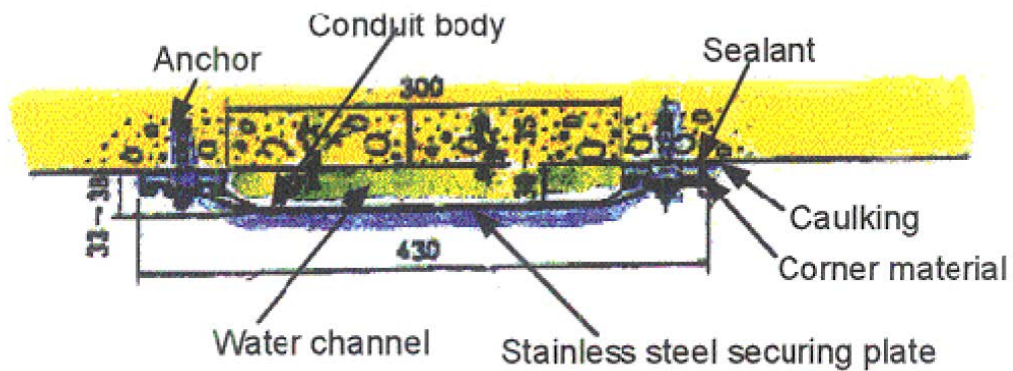

**Figure 3.10** – Conduit channel supported by steel securing plate and anchored to concrete roof for conveying water leakage (Russell, 2001)

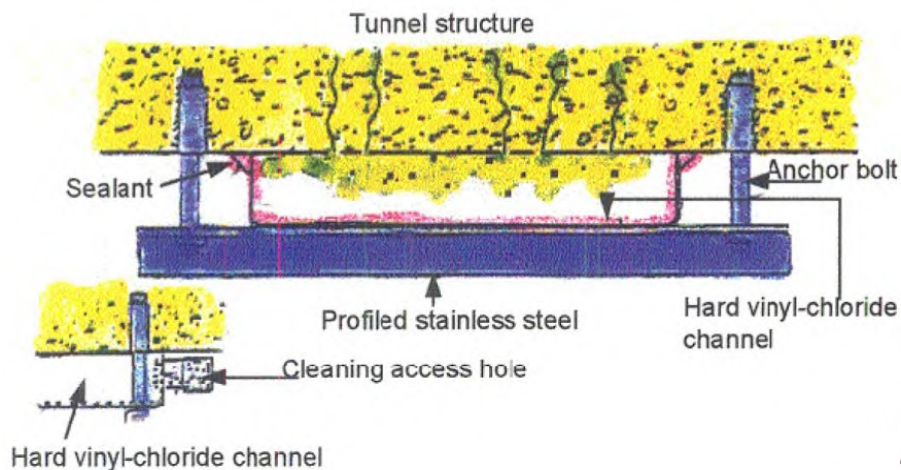

**Figure 3.11** – Hard vinyl-chloride channel supported by profiled stainless steel and anchored to concrete roof for conveying leakage (Russell, 2001).

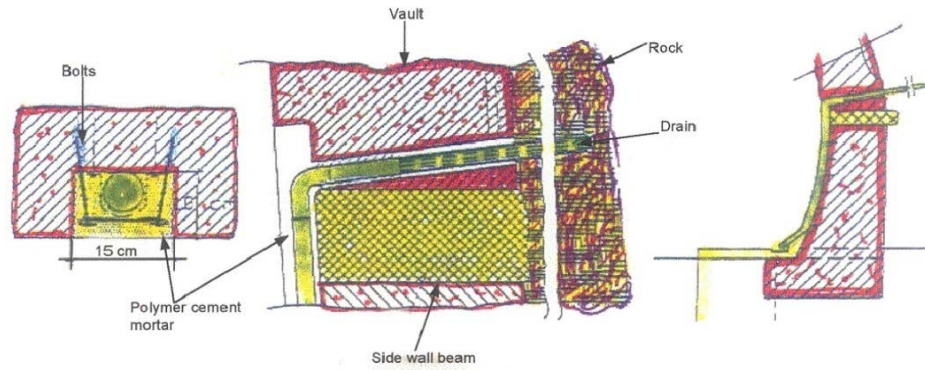

**Figure 3.12** – Radial drainage holes drilled through tunnel sidewall to relieve external water pressure. The pipe shown is encased in polymer mortar (Russell, 2001).

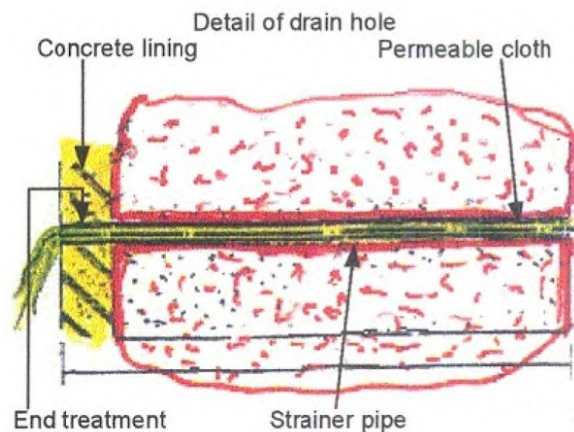

**Figure 3.13** – Radial drainage hole drilled through tunnel sidewall to relieve external water pressure. Strainer pipe is wrapped with a permeable cloth to prevent clogging (Russell, 2001).

### 3.6.2 Interior Composite Tunnel Liners (NCHRP, 2010; FHWA 2005)

A composite liner can be constructed on the interior of the tunnel liner to control unwanted seepage. This is achieved by sandwiching an impermeable membrane and geotextile between the existing tunnel liner and a new layer of applied shotcrete (See Figure 3.14). A geotextile is used to protect the impermeable membrane from damage and provide a path for drainage. For more significant drainage, a geo-drain can be used. High Density Polyurethane (HDPE) and Polyvinyl Chloride (PVC) create an impermeable barrier. The application of shotcrete protects the geomaterials against fires. Figure 3.15 through Figure 3.20 depict some common schemes that have been reported in the literature (Russell, 2001).

Prior to installation of the composite liners, the surface areas should be cleaned using small chipping hammers, high velocity water sprayers, or wire brushes. Cracks and joints that leak should first be sealed. Placing a heat-sealed patch over anchorage locations is considered “good practice” to minimize the chances future leaking.

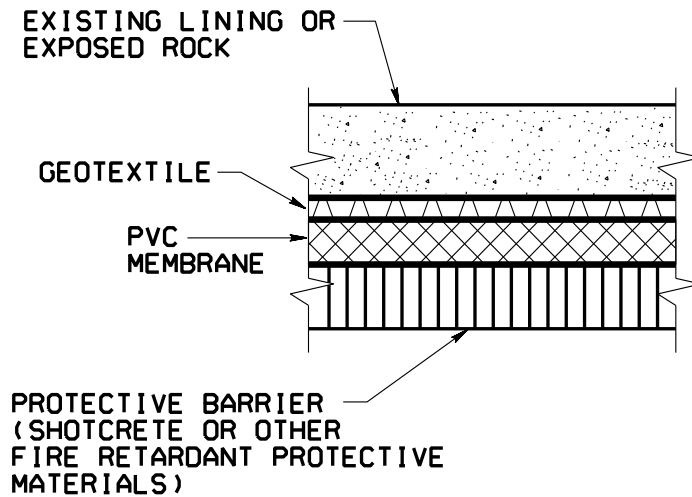

Figure 3.14 – Section of membrane waterproofing system (FHWA, 2005).

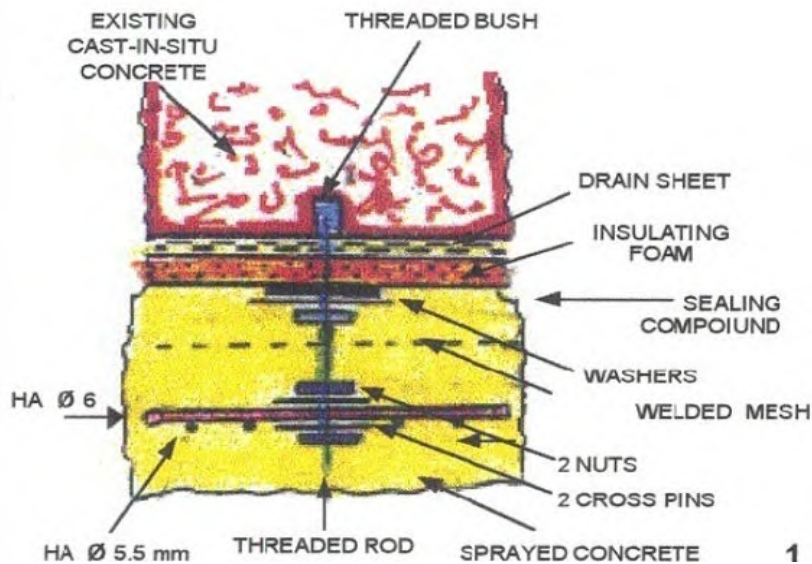
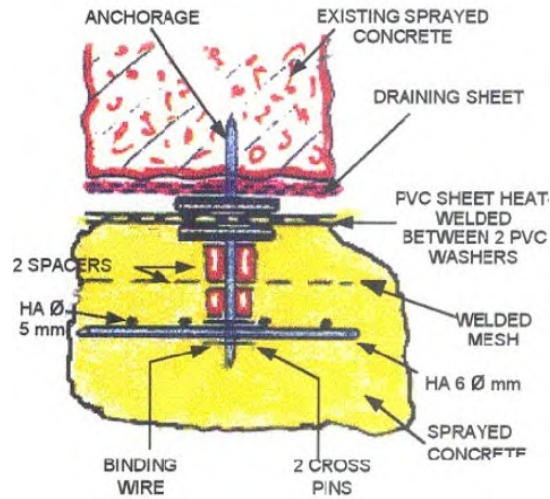
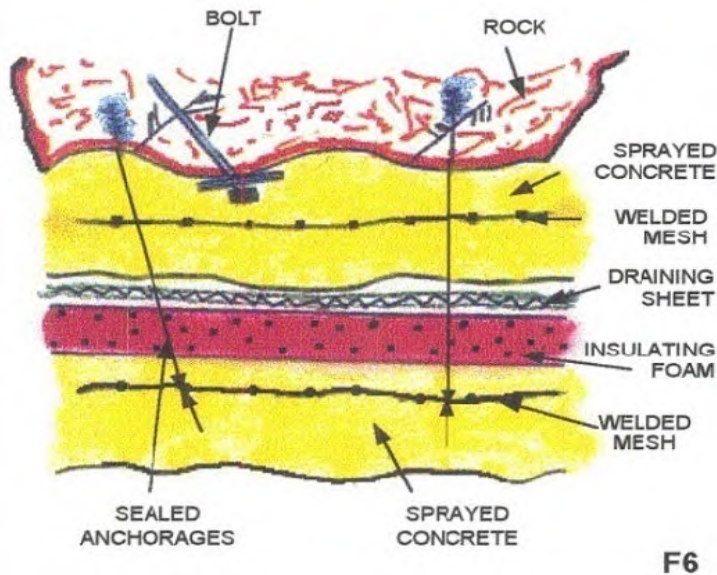

Figure 3.15 – Sealing of leakage water using a drain sheet, insulating foam, and reinforced welded-mesh sprayed concrete. This system is anchored to existing concrete via a threaded rod and nuts/washers (Russell, 2001).

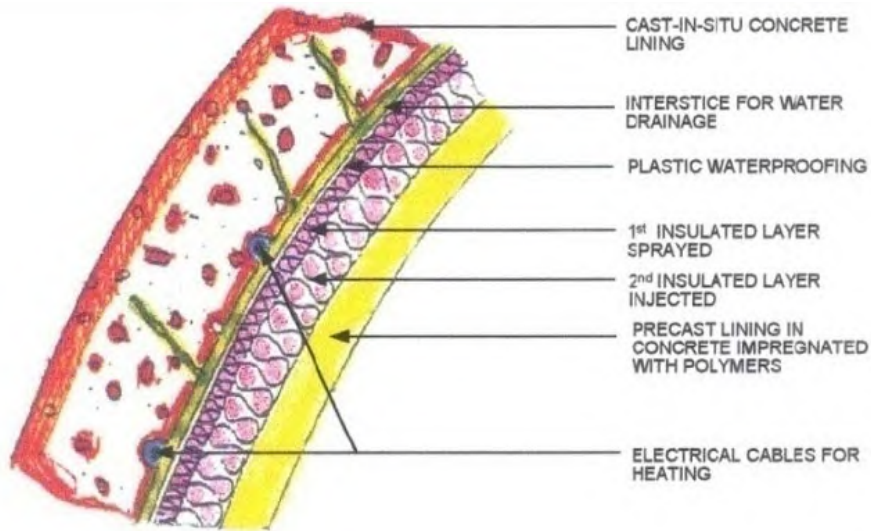

**Figure 3.16** – Sealing of leakage water using a drain sheet, PVC sheet heat-welded between washers, and a reinforced, welded-mesh sprayed concrete anchored to the existing concrete surface (Russell, 2001).

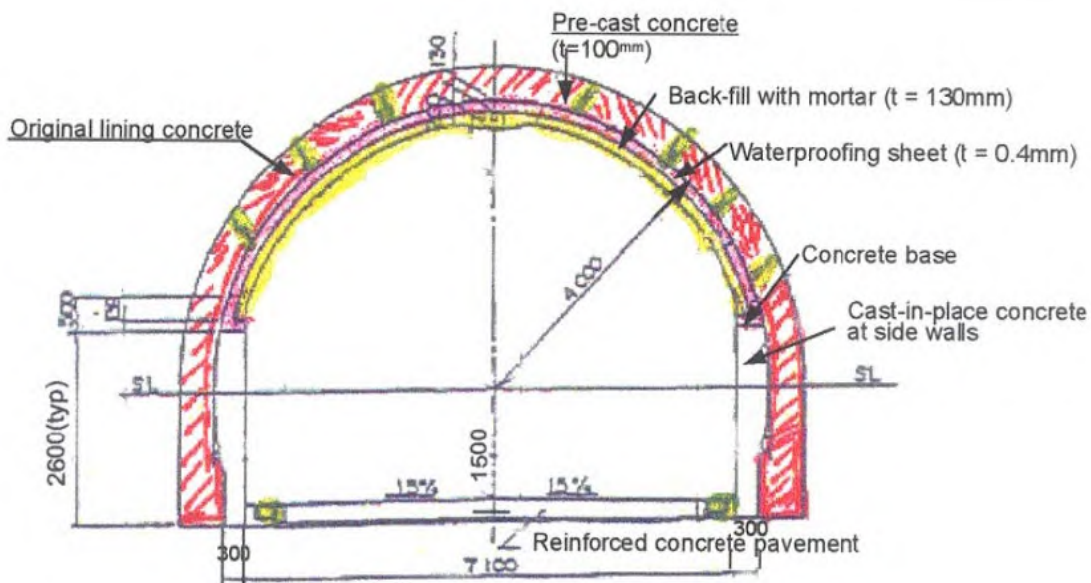

**Figure 3.17** – Leakage control in an unlined rock tunnel using a welded-mesh sprayed concrete layer, a drainage sheet, insulating foam, and a protective layer of welded-mesh, reinforced sprayed concrete (Russell, 2001).

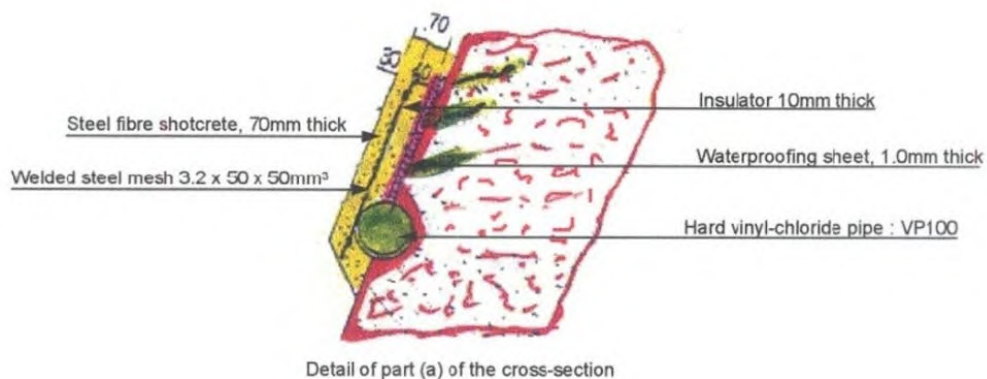



**Figure 3.18** – Leakage control on the interior face of an existing concrete tunnel using a space for water drainage, electrical heating cables, plastic waterproofing, sprayed insulating layer, and an interior precast liner (Russell, 2001).



**Figure 3.19** – Sealing of leakage water on the interior concrete face by placing a waterproofing sheet and a protective reinforced mortar layer (Russell, 2001).



**Figure 3.20** – Collecting leakage water via a waterproofing sheet, a vinyl-chloride pipe, and covering with a protective layer of reinforced steel-mesh shotcrete (Russell, 2001).

Water that is circulating can cause negative-side waterproofing sheets to detach. Insufficient anchoring, poor welding, and improper materials are common problems (See Figures 3.21 and 3.22).



**Figure 3.21** – Insulated panels under waterproofing membrane in air plenum region above roadway have dislodged in an isolated location (NCHRP, 2010).



**Figure 3.22** – Failed installation of waterproofing membrane in air plenum. Note that heat welded attachments did not penetrate the white waterproofing membrane (NCHRP, 2010).

### 3.6.3 Exterior Groundwater Barriers

Exterior groundwater barriers are difficult to install in existing tunnels. When the appropriate provisions are incorporated into the design, some leaking elements can be treated with sealants. In extreme cases, external barriers may be installed to form an impermeable cutoff wall; however, this method is expensive and may not always be feasible. When tunnels are constructed in fractured rock, the discontinuities can be grouted with some success to form an exterior curtain; however with this approach, the leaks are generally “chased” to a new location. Russell (2001) discusses ascending and descending-stage grouting methods.

- Descending-stage grouting is accomplished by drilling the borehole to shallow depths and injecting rock mass with grout starting with the packer near the rock surface. A packer is an expandable membrane that seals the annulus of the borehole between the drill string and the ground to help prevent the grout from leaking out of the borehole. When the first stage is completed, the hole is then drilled deeper to reach the lower areas of the rock. During the second stage, the packer is placed either at the top or bottom of the zone to be treated. Descending-stage grouting is recommended when the rock mass is weak, highly fractured, or otherwise needs to be consolidated before grouting the deeper zones under higher application pressures.
- For ascending-stage grouting, the grout hole is drilled to the full planned depth; and then the grouting is carried out in stages with the packer located at the top of the lowest

grouting stage. For each subsequent grouting stage, the packer should be raised to the next stage and repeated until the grouting is complete in the rock mass.

### **3.7 Repairs for Structural Concrete**

When the concrete has areas impacted by spalling, mortar patches can be applied by hand to patch smaller areas while larger areas are more effectively treated using shotcrete based application methods and economies of scale. When cracks in the concrete need to be repaired, the cracks can be injected with grout. FHWA (2009) and AASHTO (2010) describe these types of repair methods. The links below take the reader to these publications:

- Hand applied mortar patches and shotcrete repairs
  - Surface preparation
    - Chipping hammers
    - Hydro-demolition
  - Treatment of reinforcing steel

[http://www.fhwa.dot.gov/bridge/tunnel/pubs/nhi09010/tunnel\\_manual.pdf#page=513](http://www.fhwa.dot.gov/bridge/tunnel/pubs/nhi09010/tunnel_manual.pdf#page=513)

- Injecting cracks with grout.

[http://www.fhwa.dot.gov/bridge/tunnel/pubs/nhi09010/tunnel\\_manual.pdf#page=521](http://www.fhwa.dot.gov/bridge/tunnel/pubs/nhi09010/tunnel_manual.pdf#page=521)

#### **3.7.1 Cementitious Coatings**

Cementitious coatings (See Figures 3.23 and 3.24) can be sprayed onto a moist concrete surface to help reduce its permeability. Maintaining a moist surface will facilitate the formation of chemical bonds with the free lime contained in the substrate concrete and reduce the pore sizes, which tends to inhibit seepage. FHWA (2009) and AASHTO (2010) publications describe methods for applying negative side cementitious coatings:

[http://www.fhwa.dot.gov/bridge/tunnel/pubs/nhi09010/tunnel\\_manual.pdf#page=510](http://www.fhwa.dot.gov/bridge/tunnel/pubs/nhi09010/tunnel_manual.pdf#page=510)

The advantages are:

- Rapid installation
- Minimal disruptions
- Relatively low cost

The disadvantages are:

- Rigid
- Not self-healing
- Sensitive to movement.



**Figure 3.23** –View of a cementitious coating applied to the arch (NCHRP, 2010).



**Figure 3.24** – Leakage at a construction joint through the cementitious coating (NCHRP, 2010).

### 3.7.2 Construction Joints (NCHRP, 2010)

If the construction joints are leaking, then chemical grout can be injected to seal the joint. Defects such as delaminations and spalls near the joint should be removed and rebuilt with sound materials having properties similar to the concrete substrate. While performing the work, seepage water can be directed into the drainage system using flexible drainage pipe (See Figure 3.25).

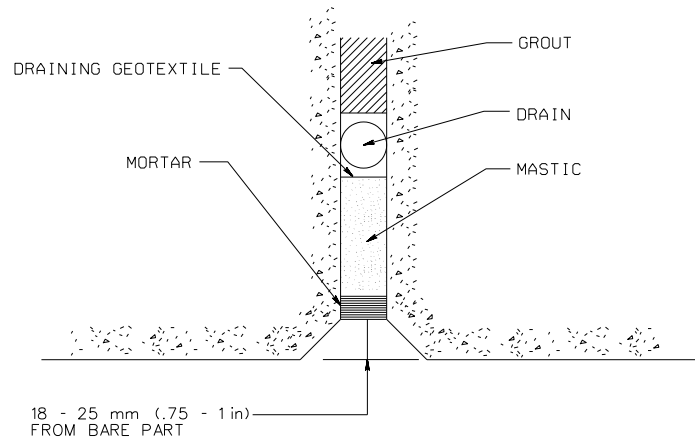

**Figure 3.25** – Routing a Construction Joint

### 3.7.3 Dry Cracks (NCHRP, 2010)

“Dry” cracks (generally greater than 1/32” in width) can be repaired on a horizontal surface by damming the edges of the crack and allowing the sealant to penetrate into the crack as indicated in Figure 3.26. Seal the underside of the crack if the epoxy drips through. In all cases the cracks should be cleaned of all loose matter, dirt, and stains using high pressure water or compressed air.

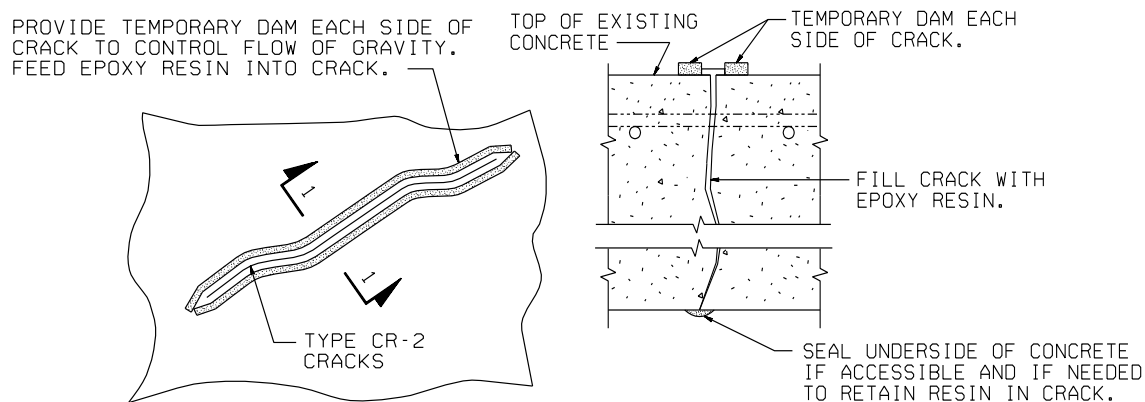

**Figure 3.26** – Section 1-1 – horizontal surface crack repair detail (for cracks 0.8 mm (1/32”) wide and greater) (FHWA, 2005).

### **3.7.4 Re-bonding Delaminated Areas**

Delaminated concrete is characterized by splitting and cracking in a plane that is roughly parallel the surface. Delaminated sections are usually relatively shallow. When a section of delaminated concrete becomes detached from the host element, then it is considered to be spalled.

Delaminated areas, such as ceramic tiles, can sometimes be re-bonded using a vacuum injection process (See Figure 3.27).



**Figure 3.27** – Vacuum Injection with Methyl Methacrylate (NCHRP, 2010).

### **3.7.5 Freeze/Thaw and Salt Penetration (NCHRP, 2010)**

In colder climates, the invert of the roadway may be treated with salt to preclude the formation of ice on the wearing surface, especially near the tunnel portals. The chloride ions in the salt can seep into adjacent concrete structures and accelerate the rate of corrosion in the reinforcing steel, which can lead to spalled concrete or an increased rate of potholes. In older tunnels built before 1950, the concrete was usually batched without air-entrainment admixtures. The natural air-entrainment in these old concrete structures may not be sufficient to adequately resist the damage caused by repetitive freeze/thaw cycles.

### **3.8 Other Types of Structural Repairs (FHWA, 2009) and (AASHTO, 2010)**

The following links take the reader to repair information contained in other documents:

- Segmental liners
  - Precast concrete
  - Steel/Cast iron

[http://www.fhwa.dot.gov/bridge/tunnel/pubs/nhi09010/tunnel\\_manual.pdf#page=522](http://www.fhwa.dot.gov/bridge/tunnel/pubs/nhi09010/tunnel_manual.pdf#page=522)
- Steel liners

[http://www.fhwa.dot.gov/bridge/tunnel/pubs/nhi09010/tunnel\\_manual.pdf#page=524](http://www.fhwa.dot.gov/bridge/tunnel/pubs/nhi09010/tunnel_manual.pdf#page=524)
- Masonry liners

[http://www.fhwa.dot.gov/bridge/tunnel/pubs/nhi09010/tunnel\\_manual.pdf#page=525](http://www.fhwa.dot.gov/bridge/tunnel/pubs/nhi09010/tunnel_manual.pdf#page=525)
- Unlined Rock Tunnels

[http://www.fhwa.dot.gov/bridge/tunnel/pubs/nhi09010/tunnel\\_manual.pdf#page=525](http://www.fhwa.dot.gov/bridge/tunnel/pubs/nhi09010/tunnel_manual.pdf#page=525)

#### **3.8.1 Timber Liners**

Timber liners sometimes need periodic treatments to prevent the spread of decay. Some common wood treatments include:

- Boron compounds
- Copper chromium arsenic compounds
- Light organic solvent preservatives or tributyl tin oxide (TBTO).

When the timbers are badly deteriorated, these elements are often encased in shotcrete to preserve the integrity of the liner (See Figures 3.28 and 3.29).



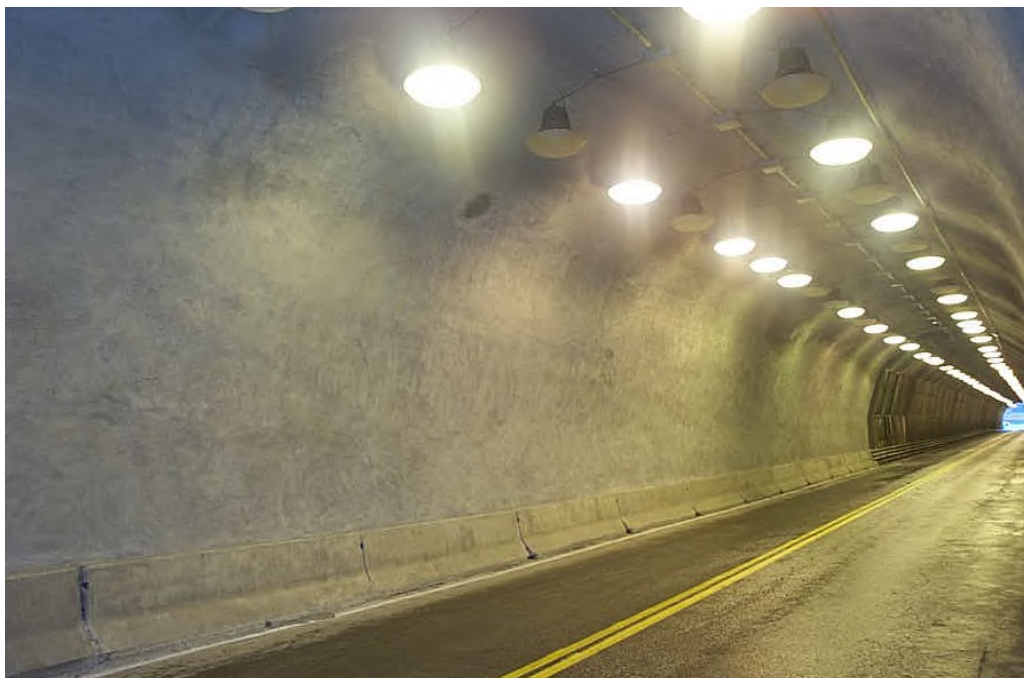

**Figure 3.28** – New shotcrete lining over timber supports in rock tunnel. Note timber supports can be seen in the background (NCHRP, 2010).



**Figure 3.29** – Interface between timber supports and new shotcrete (NCHRP, 2010).

### 3.8.2 Ceilings/Hangers and Anchorages

Numerous highway tunnels have suspended ceilings for ventilation purposes and, in some cases, aesthetics. These ceilings are usually supported by keyways in the tunnel walls and by hanger rods attached to the tunnel liner, either by means of cast-in-place inserts or post-installed mechanical. Examples are shown in Figure 3.30. See cautionary note below on adhesive (chemical) anchors. Loose or failed adhesive connections should be replaced with mechanical anchors.

*FHWA issued a Technical Advisory in 2008 that strongly discourages the use of adhesive anchors for use with permanent sustained loads in tension or overhead applications. The use of anchors in road tunnels should conform to current FHWA advisories and other applicable codes and regulations.*

<http://www.fhwa.dot.gov/bridge/t514030.cfm>



**Figure 3.30** – Typical replacement hardware left; undercut mechanical anchors, right.

### **3.9 Maintenance of Functional Systems**

Functional systems include the mechanical, electrical, lighting, fire and life safety, security, sign, and protective systems installed in the tunnel. The equipment rooms for these functional systems, such as the ventilation buildings, pump rooms, and emergency generator rooms, should be kept clean. Remove any debris, grease and oil. Loose debris can damage equipment. All gauges, sight glasses, indicator lights, and safety equipment must be cleaned and checked. Some components might require painting. Movable components should be exercised periodically. Ideally, maintenance programs can be enhanced by collecting data and managing the maintenance activities.

- Computerized maintenance management systems (CMMS) include software that:
  - Generates maintenance, repair, and replacement related work orders
  - Stores historical maintenance, repair, and cost data
  - Analyzes maintenance data (trends) and stores costs
  - Calculates life-cycle costs for individual systems and equipment
- Measurements can be recorded on maintenance logs, checklists, or hand held tablets. Some of the data to be considered for the maintenance management program include the following items:
  - Equipment running hours
  - Ferrous wear particle count in lubricating oils
  - Bearing and drive operating temperatures
  - Vibration of rotating equipment
  - Repair costs of individual equipment

#### **3.9.1 Maintenance Tools for Functional Systems**

There are many tools that can be used to enhance the maintenance checks for functional systems.

**Handheld Infrared Thermometers** – Handheld infrared thermometers are useful to spot check the temperature of bearings, drive components, couplings, pipe insulation, steam traps, electrical transformers, and motors. Temperature information is useful for identifying the early onset of problems. Temperature data can also be input into the database for identifying possible problems and trends.

**Infrared Thermography** – Infrared thermography, or thermal imaging, is useful for identifying a wide range of problems such as:

- Bearing or drive belt/chain friction/wear
- Bearing lubrication contamination; breakdown or conditions of low lubrication levels
- Motor/drive misalignment or pending coupling failure
- Compromised pipe insulation
- Steam trap failure
- Electrical faults

**Ultrasonic Testing** – Ultrasonic testing uses sound to identify leaking fluids through valves.

**Vibration Analysis of Rotating Equipment** – Modern vibration measurement instruments (with analysis software) allow for periodic or continuous monitoring of rotating parts. These instruments allow better predictions of potential failures.

**Lubrication Sampling and Testing** – Use of periodic oil sampling for bearings, drive lubricants, and electrical transformers is helpful for tracking:

- Machine conditions
- Lubrication breakdown/viscosity
- Iron/ferrous wear particles
- Lubricant contamination
- Moisture contamination of lubricant

### 3.9.2 **Maintenance Certifications for Complex or Dangerous Equipment**

Specialty purpose contractors are often certified to work on certain types of equipment due to inherent dangers. This may be required by local laws and ordinances. Check and comply with the State and local requirements prior to working on:

- Boilers
- Water Heaters
- Pressure Vessels
- Elevators
- CO Monitoring
- Fire Suppression Systems
- Fire Extinguishers
- Fire Standpipes

### 3.9.3 **Mechanical Systems**

The link below provides the reader to a table of various mechanical components and their suggested maintenance intervals (FHWA, 2005). The table can be used to supplement an existing

maintenance program at the discretion of the tunnel owner. *Since the table is generalized, specific and manufacturer recommended maintenance practices should take precedence over the suggestions contained in the table.*

<http://www.fhwa.dot.gov/bridge/tunnel/maintman03.cfm#t02>

### 3.9.3.1 Fans

Tunnel Ventilation Fans – Since tunnel ventilation fans are critical to the operation of a tunnel and essential for fire and life safety in emergencies, these elements must work when needed (See Figure 3.31). The following items are important maintenance considerations for vent fans:

- Excessive heat and moisture in lubricant are the two leading causes of premature bearing failure.
- Daily inspection and temperature monitoring can be used to help identifying lubrication problems.
- A supplemental lubricant testing program can be used to help validate the maintenance schedule and identify potential problems. The testing should be performed by a certified laboratory using appropriate ASTM and ISO standards.



**Figure 3.31 – Mechanical Fan**

### **3.9.3.2 Pumps**

There are three broad categories of pumps. These include reciprocating, rotary, and centrifugal. Centrifugal pumps are the most common for tunnel applications. When performing maintenance checks, the motors should be checked for excess temperatures and unusual vibrations. Typically, the pump is controlled by an electrode or float switches in the sump. Examine the check valves and discharge piping.

### **3.9.4 Electrical and Lighting Systems**

Due to issues with worker safety, electrical maintenance and testing should only be performed only by qualified professionals. It is recommended that the staff be certified in Occupational Safety and Health Administration (OSHA) Standards and competent with NFPA Standards *70E: Standard for Electrical Safety Requirements for Employee Workplaces*.

The link below provides the reader to a table of various electrical and lighting components and their suggested maintenance intervals (FHWA, 2005). The table can be used to supplement an existing maintenance program at the discretion of the tunnel owner. *Since the table is generalized, specific and manufacturer recommended maintenance practices should take precedence over the suggestions contained in the table.*

<http://www.fhwa.dot.gov/bridge/tunnel/maintman03.cfm#t03>

#### **3.9.4.1 Electrical Systems**

Electrical components are interconnected and rely on other elements to function properly (Figure 3.32). The InterNational Electrical Testing Association (NETA) produces *Maintenance Testing Specifications (MTS-2007)* that contain detailed information and guidelines about performing maintenance on electrical equipment. The National Fire Protection Association's *NFPA 70B: Recommended Practice for Electrical Equipment Maintenance* is also suggested for incorporation into a tunnel maintenance program.

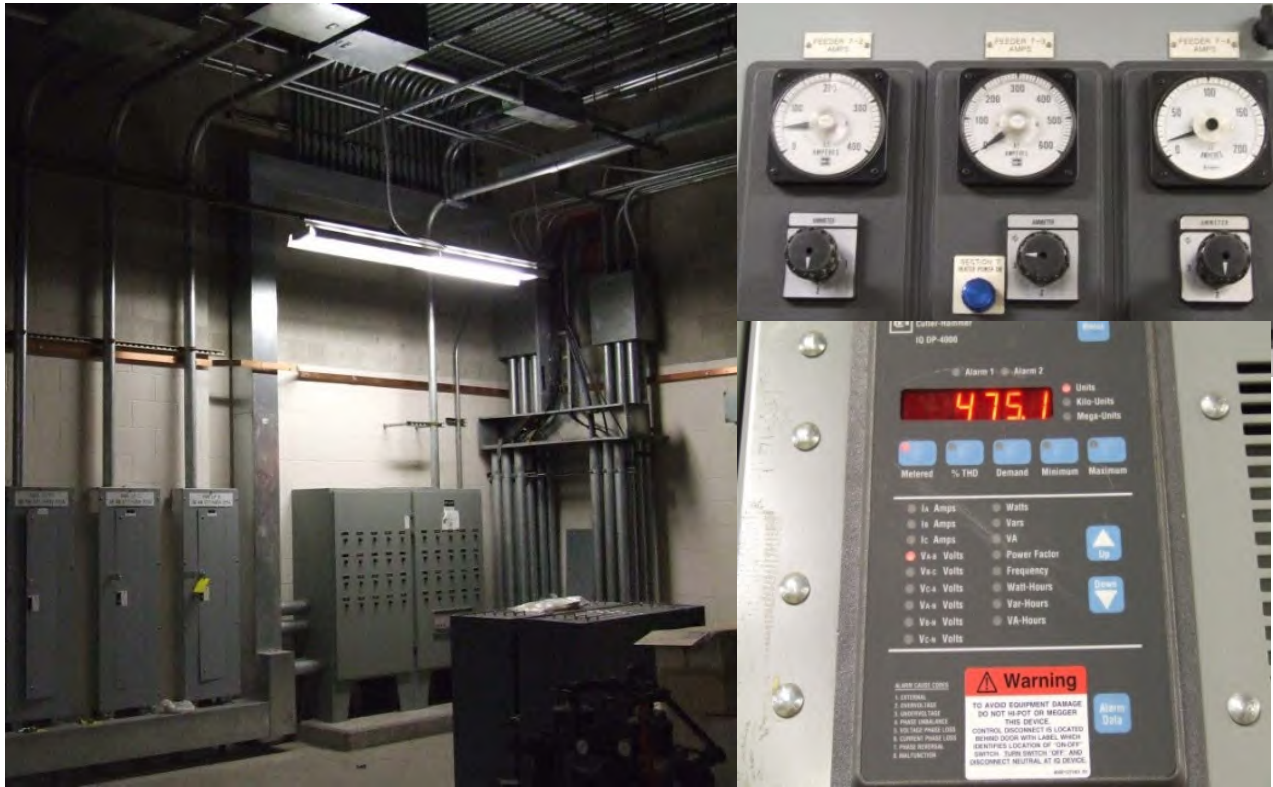

**Figure 3.32** – Electrical system components.

### **3.9.4.1.1 Cable and Conduit Replacement**

Electrical conduit carries electrical wiring and protects it from impact, harsh environments, moisture, chemicals, and corrosives. Depending on their design, conduits often carry a variety of wiring types and sizes. Conduit systems should be inspected to evaluate the effects of corrosion or impact damage. It is possible to repair conduit in the early stages of corrosion, but if the condition worsens, the conduit may need to be removed and replaced. The use of a conduit permits the replacement of cables with minimal disruption to other systems. When junction and pull boxes are a part of an integrated system, the replacement of a cable segment requires much less effort.

### **3.9.4.1.2 Electrical Conduit Banks**

Tunnels often contain many electrical conduits placed on conduit trays. The exterior conduit covering should be checked to ensure that it protects the electrical wires and is solidly mounted. These items should be inspected for signs of impact and other types of damage.

### 3.9.4.2 Lighting Systems

Maintenance programs can be supplemented using information obtained from the ANSI/IES Lighting Handbook. Cleaning should take place periodically. The Luminaire Dirt Depreciation (LDD) factor is a method to account for optimizing the cleaning interval. This method takes into account the degradation of light output on lenses, refractors, lamps, and reflectors due to the accumulation of dirt. Figure 3.33 depicts the maintenance and cleaning of the lighting system.



**Figure 3.33** – Tunnel lighting maintenance and cleaning.



### 3.9.5 Fire and Life Safety Systems

The tunnel fire and life safety systems are relatively complex; these systems contain interconnected sophisticated components that function together to enhance safety against fire and smoke (See Figure 3.34). Table 3-4 provides suggested intervals for performing preventive maintenance functions on major pieces of equipment commonly used with fire and life safety systems. *Specific and manufacturers' recommended preventive maintenance procedures should take precedence over the guidelines contained in the table.*

#### 3.9.5.1 Inspection Certifications

Equipment and system certifications should be posted at the equipment locations as required. Additionally, it is recommended these certificates be filed and retained. It is common to provide inspection certificates for the following equipment:

- CO Monitoring
- Fire Suppression Systems
- Hydrocarbon Detectors
- Portable Fire Extinguishers

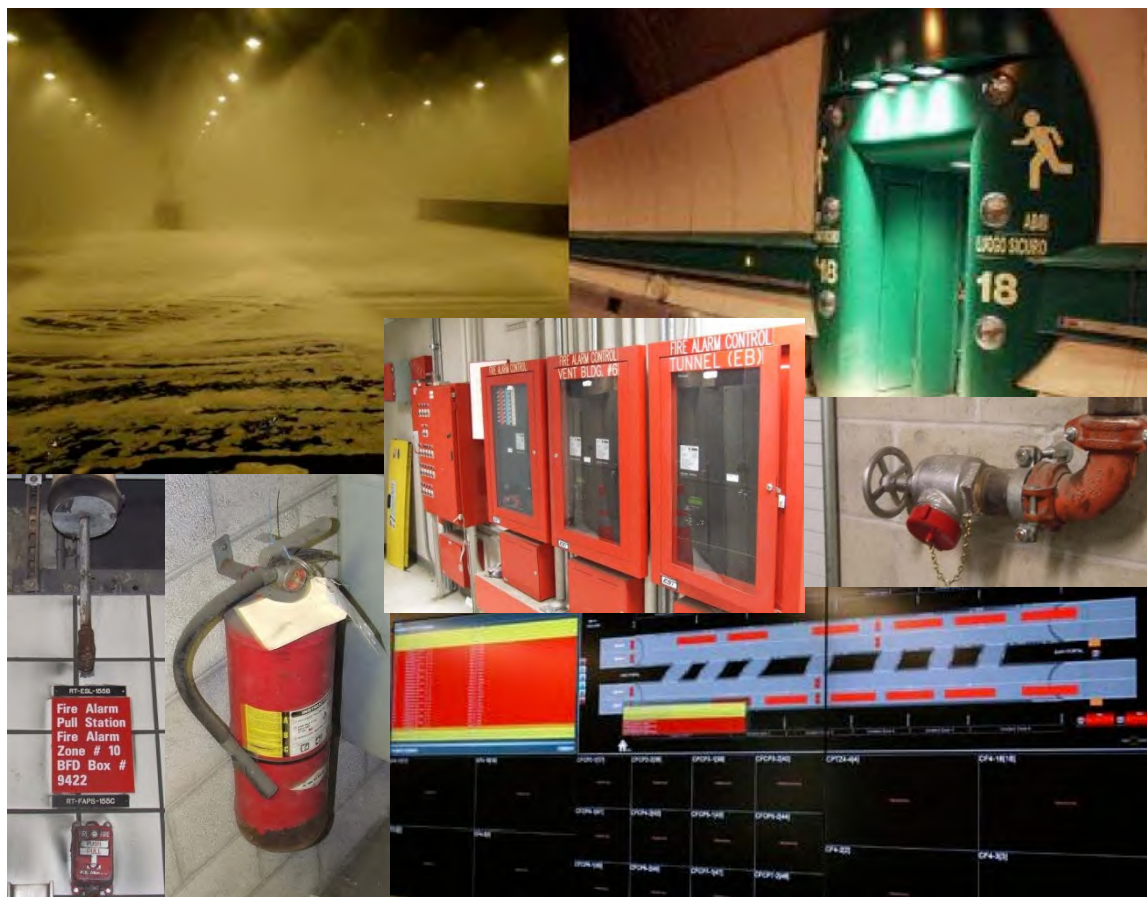

Figure 3.34 – Fire and life safety components.

**Table 3-4 – Example Maintenance Intervals for Fire and Life Safety Systems**

Fire and Life Safety Systems	Service Interval (1)							
	Daily	Weekly	Monthly	Quarterly	Semi-Annually	Annually	Bi-Annually	Manufacturer or AHJ (2)
<b>Fire Protection</b>								
Inspect Manual Fire Alarm Boxes			X					
Closed-Circuit TV (CCTV) – Confirm Operation	X							
Automatic Fire Detectors				X				
<b>Fire Extinguishers</b>								
Inspect each fire extinguisher in the tunnel and support spaces				X				
If in a cabinet – Confirm operation of cabinet door – Door must latch securely and open freely				X				
Lubricate door handle and hinges as necessary				X				
<b>Fire Standpipes</b>								
Fire Department Connections Capped and Clear				X				
Confirm threads are undamaged and caps in place				X				
Test flow hydrant				X				
Confirm top nut and caps are tight but not over-torqued				X				
<b>Fire Hydrants</b>								
Grease top nut					X			
Confirm cap's in place					X			
Test flow hydrant					X			
Confirm top nut and caps are tight but not over-torqued					X			
<b>Fire Lines</b>								
<i>Freeze Protection Pumps</i>								
Clean and visually inspect				X				
Lubricate and grease pumps						X		
Heat Tracing – Verify system operation (prior to system operation)						X		
Pipe Insulation with Heat Tracing - Verify condition (prior to system operation)						X		

Fire and Life Safety Systems	Service Interval (1)							Manufacturer or AHJ (2)
	Daily	Weekly	Monthly	Quarterly	Semi-Annually	Annually	Bi-Annually	
<b>Fire Pumps</b>								
Visually inspect fire pump		X						
Operate pump – Note unusual noises or vibrations				X				
Lubricate pump, motor, and coupling								X
Operate pump and measure current					X			
Check shaft alignment and shaft endplay					X			
Check and correct pressure gauges as required					X			
Measure motor and pump vibration				X				
<b>Fire Pump Controller</b>								
Exercise disconnect switch and circuit breaker		X						
Operate pumps from alternate and primary power supplies		X						
Conduct annual test of system including flow and no flow conditions in accordance with NFPA 72						X		
<b>Fire Tank Fill Pump</b>								
Visually inspect pump		X						
Operate pump – Note unusual noises or vibrations						X		
Lubricate pump, motor, and coupling				X				
Check shaft alignment and shaft endplay				X				
Secondary containment provided for all hazardous materials		X						
MSDS sheets for all materials posted (on file)					X			
Inspect all floors for oil leakage. Add absorbent and clean as required to maintain safe footing	X							
<b>Fire Alarm System</b>								
<i>Perform all tests and inspections in accordance with NFPA 72</i>								
<i>Make and file a permanent record of all inspections and tests conducted</i>								
Open primary power supply to fire alarm panel and note sounding of trouble alarm and light		X						
Perform fire drill by use of drill switch on fire alarm panels, and check that all visual and audible signals emit a sound and tunnel SCADA system (if any) receives alarm		X						

<b>Fire and Life Safety Systems</b>	<b>Service Interval (1)</b>							
	Daily	Weekly	Monthly	Quarterly	Semi-Annually	Annually	Bi-Annually	Manufacturer or AHJ (2)
Visually inspect all supervisory and water flow alarms on any standpipe systems		X						
Test all heat detectors with a calibrated heat source and replace all failed units					X			
Test all smoke detectors by measuring and recording sensitivity; replace all failed units					X			
Clean all smoke and heat detector housings and check battery voltage under load					X			
Verify that proper alarm devices operate for the appropriate initiating device circuit					X			
Verify that all remote annunciators operate				X				
Check all lamps, alarm devices, and printers for proper operation				X				
Make a discharge test of batteries to determine capacity for operating system for 24 hours					X			
<b>Communications</b>								
Radio	X							
Telephone	X							
<b>Egress</b>								
Emergency Egress		X						
Exit Lighting/Signage/Identification		X						
Tenable Environment (Note: Smoke Control Ventilation is located in Fire Suppression Section)		X						
Emergency Exits		X						
Cross-Passageways		X						
<b>Electrical</b>								
Emergency Lighting			X					
Power			X					

Fire and Life Safety Systems	Service Interval (1)							
	Daily	Weekly	Monthly	Quarterly	Semi-Annually	Annually	Bi-Annually	Manufacturer or AHJ (2)
Redundant Power			X					
Security Plan			X					
<b>Emergency Response Plan (ERP)</b>								
ERP on File and all Personnel Aware of Requirements					X			
ERP reviewed and update periodically					X			
Tunnel Personnel Training of execution of ERP			X					
Training Exercises with Participating Agencies						X		
<b>Hydrocarbon Detector</b>								
Confirm Hydrocarbon Detector will initiate local and remote alarms								X
<b>CO Monitoring Equipment</b>								
Tunnel (Local) Sensors (Confirm Calibration and/or sensor replacement)								X
Vacuum Tubing (Leak Test)				X				
Vacuum Pump (lubrication)				X				
Central Sensor								X
System Calibration (as required by individual system)								X
Comparison Gas Refill (as required)								X
<b>Life Safety and Fire Code Issues (Flammable/Hazardous Materials)</b>								
All safety guards and covers (belt, chain, electrical panel) in place and secure.		X						
No plastic (PVC, CPVC) pipe located in supply air passages.					X			
All batteries properly stored and vented. Confirm battery charging only taking place in well ventilated spaces.		X						
Flammable material stored in proper containers and properly ventilated spaces.		X						
Secondary containment provided for all hazardous materials		X						
MSDS sheets for all materials posted (on file)					X			
Inspect all floors for oil leakage. Add absorbent and clean as required to maintain safe footing	X							

Fire and Life Safety Systems	Service Interval (1)							
	Daily	Weekly	Monthly	Quarterly	Semi-Annually	Annually	Bi-Annually	Manufacturer or AHJ (2)

Notes:

- (1) The above table is intended as a guide. In all cases, maintenance should be performed in accordance with the manufacturer’s specific recommendations.
- (2) Perform in accordance and as recommended in unit manufacturer’s literature or inspect on an interval required by the local authority having jurisdiction (AHJ).

### 3.10 Signs and Communication Devices

Tunnel facilities contain several different types of signs, including exit and entry signs for ramps, speed limit signs, variable message signs, and emergency egress signs for motorists who may need to evacuate on foot in case of a fire event. Routine maintenance is required to ensure attachment hardware is intact (bolts are tight, bolts are embedded properly, and the anchorage to the foundations is crack free), dirt accumulation is removed to maintain visibility and reflectivity, and burnt out bulbs are replaced.

### 3.11 Corrosion Protection Systems

Corrosion protection systems include coatings (e.g., epoxies, powder coatings, paint or galvanizing), high-density concrete cover, tunnel finishes (e.g., tiles, metal panel, or coatings), and cathodic protection systems.

Protective coatings are usually sprayed-on epoxy paint or cementitious coatings over bare concrete surfaces. Epoxy paint provides good reflectivity off the tunnel ceiling and walls, brightening the tunnel environment and improving safety. Vehicle exhaust and overspray will dull these epoxy coatings, causing them to lose reflectivity. Regularly scheduled washing will restore reflectivity; however, numerous washing cycles will eventually degrade these coatings to a condition that necessitates repair or complete reapplication.

Cathodic protection systems are comprised of a sacrificial material (anode) to protect the primary metal from corrosion. In highly corrosive environments, an electrical current is induced in the material to force corrosion to occur in the sacrificial anode. If an impressed current is used to protect the reinforcing steel, periodic maintenance and inspection of the system is necessary to ensure that the system is working as designed.

## References

ANSI/IESNA (2005) RP-22-05, Recommended Practice for Tunnel Lighting

Federal Highway Administration (2005), *Highway and Rail Transit Maintenance and Rehabilitation Manual*, FHWA-IF-05-017, Washington, DC.

Federal Highway Administration, December 2009, *Technical Manual for Design and Construction of Road Tunnels – Civil Elements*, Publication No. FHWA-NHI-10-034, Washington, DC.

National Cooperative Highway Research Program, July 2010, *Development of Guidelines for Rehabilitation of Existing Highway and Rail Transit Tunnels*, Project 20-07/Task 276, Transportation Research Board, National Research Council, Washington, DC.

Russell, et al., *Study Methods for Repair of Tunnel Linings*, Working Group to Repair and Maintenance of Underground Structures, International Tunneling Association (ITA – AITES), Lucerns, Switzerland, 2001.

Ryan, T.W., Hartle, R.A., Mann, J.E., and Danovich, L.J., (2006), *Bridge Inspector's Reference Manual*.

American Society of Heating, Refrigerating and Air-Conditioning Engineers, Inc. (ASHRAE) ASHRAE Guideline 4-2008, *Preparation of Operating and Maintenance Documentation for Building Systems*.

American Society of Heating, Refrigerating and Air-Conditioning Engineers, Inc. (ASHRAE) ANSI/ASHRAE/ACCA Standard 180-2008, *Standard Practice for Inspection and Maintenance of Commercial Building HVAC Systems*.

ASTM E1728 - Standard Practice for Collection of Settled Dust Samples Using Wipe Sampling Methods for Subsequent Lead Determination.

ASTM E1792 - Standard Specification for Wipe Sampling Materials for Lead in Surface Dust.

American Society of Heating, Refrigerating and Air-Conditioning Engineers, Inc. (ASHRAE) ASHRAE Guideline 4-2008, *Preparation of Operating and Maintenance Documentation for Building Systems*.

American Society of Heating, Refrigerating and Air-Conditioning Engineers, Inc. (ASHRAE) ANSI/ASHRAE/ACCA Standard 180-2008, *Standard Practice for Inspection and Maintenance of Commercial Building HVAC Systems*.

American National Standards/InterNational Electric Testing Association (ANSI/NETA) 2013, *Standards for Acceptance Testing Specifications (ATS) for Electrical and Power Equipment and Systems*.

American National Standards/Illuminating Engineering Society of North America (ANSI/IES), *The Lighting Handbook*.

National Fire Protection Association (NFPA) – NFPA 10, *Standard for Portable fire Extinguishers*.

National Fire Protection Association (NFPA) – NFPA 14, *Standard for the Installation of Standpipes and Hose Systems*.

National Fire Protection Association (NFPA) – NFPA 72, *National Fire Alarm and Signaling Code*.

National Fire Protection Association (NFPA) – NFPA 502, *Standard for Road Tunnels, Bridges, and Other Limited Access Highways*.

World Road Association (PIARC) – PIARC Technical Committee 3.3 Road Tunnel Operations – *Tools for Tunnel Safety Management*.